

Brinsea

OVA-EASY ADVANCE



HATCHER

User Instructions

Contents

Section	Subject	Page
1	Introduction	2
2	Unpacking	3
3	Location and Installation	3
4	Quick Reference	4
5	Digital Control System	5
6	Temperature	7
7	Humidity, Ventilation & Hatching	8
8	Cleaning up	9
9	Troubleshooting	10
10	Servicing and Calibration	11
11	Specifications	13

1 Introduction



Read the instructions before use.

These instructions detail the operation of your new Ova Easy Advance Series II Digital Cabinet Egg Hatcher. Please read these instructions carefully before setting up your machine to achieve best results and keep these instructions safe for future reference. This document includes recommended procedures for successful hatching. Your Hatcher is designed to allow the user to vary the conditions to suit a wide range of species in different ambient conditions and the specific set-up for every situation is beyond the scope of these instructions.

There is a range of books available covering incubation techniques, for more information or to request a book list please don't hesitate to contact us.

The Ova-Easy Advance Series II range are available with the option of the Advance Humidity Pump for automatic humidity control. Operating instructions for this module are supplied separately.

Fig. 1 Functional Features of the Ova-Easy Advance Series II Cabinet Hatcher.

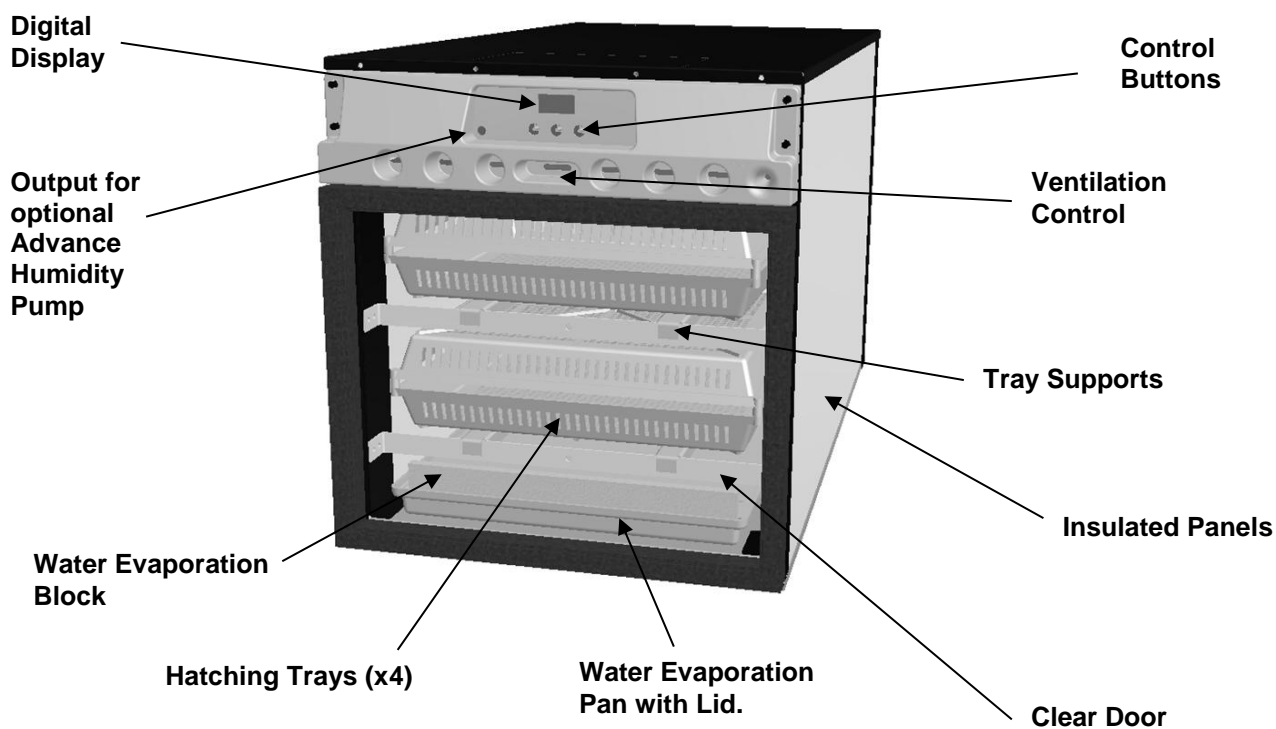

2 Unpacking & Assembly

- 2.1 Your Hatcher has been supplied in protective packaging. Please remove all tape, strapping and packing from the Hatcher parts. Retain the carton and packing materials to enable the unit to be repacked. Please check that parts are all present and undamaged. Damaged appliances shall not be used.
- 2.2 Check that the electrical supply matches the machine's requirements (marked on the technical label on the outside of the box and on the top cover of the Hatcher). The power cord set must be an appropriately rated and approved cord-set in accordance with the regulations of the country it is used in.
- 2.3 To register your new Brinsea product please visit www.brinsea.co.uk and follow the link on the right hand side of the home page to qualify for your free 2 year guarantee.
- 2.4 Go to www.Brinsea.co.uk and register as a free member of the Brinsea Email Group to receive the latest news and information such as advance notice about new products, special offers, exclusive competitions and much more.

3 Location and Installation

THE HATCHER MUST BE PLACED IN AN INDOOR AREA NOT SUBJECT TO SPLASHES OF WATER OR WET CONDITIONS AND OUT OF REACH OF ANIMALS AND CHILDREN.

- 3.1 Your Hatcher will give best results in a room free from wide temperature variations and with generous ventilation – particularly if several incubators are running at the same time. Ensure that the room temperature cannot drop on a cold night. Ideally thermostatically control the room at between 20 and 25°C (68 and 77°F). Never allow the room temperature to drop below 15°C (59°F) and ensure that the Hatcher cannot be exposed to direct sunlight.
- 3.2 Always place the Hatcher upright on a flat level surface off the floor. Ensure the surface is adequate to support the weight of the machine and contents. See weight specifications at the end of this document.
- 3.3 Place the water evaporation pan in the front of the Hatcher and fill with 1:200 mix of water and Brinsea disinfectant solution. The water level should be no higher than the first ridge of the tray. Place the Evaporation Block upright across the front of the pan (in the slot). Place the flat lid on the pan and slide the pan back into the cabinet so that the evaporation block is in front of the hatching tray support. Close the door.

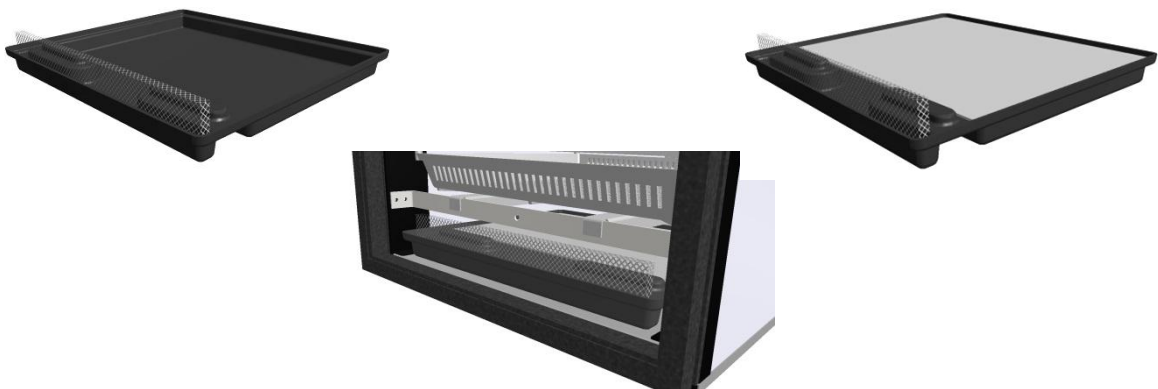

- 3.4 Plug the Hatcher supply cable into a suitable outlet ensuring that the cable is not pulled tight. The Hatcher fans will start and the LCD display will show the air temperature and humidity.

4 Quick Reference (please read relevant section for detail)

This quick reference is intended to allow users to quickly set up the Hatcher and learn the key features of the control system. Please read the rest of the instructions to obtain a full understanding of each feature.

	PRESS BOTH BUTTONS TO UNLOCK THE MAIN MENU
	SELECT THE OPTION / RETURN TO THE MENU.
	GO FORWARD ONE SCREEN / INCREASE THE VALUE / DISPLAY IN CELSIUS.
	GO BACK ONE SCREEN / DECREASE THE VALUE / DISPLAY IN FAHRENHEIT.

MAIN MENU – QUICK REFERENCE

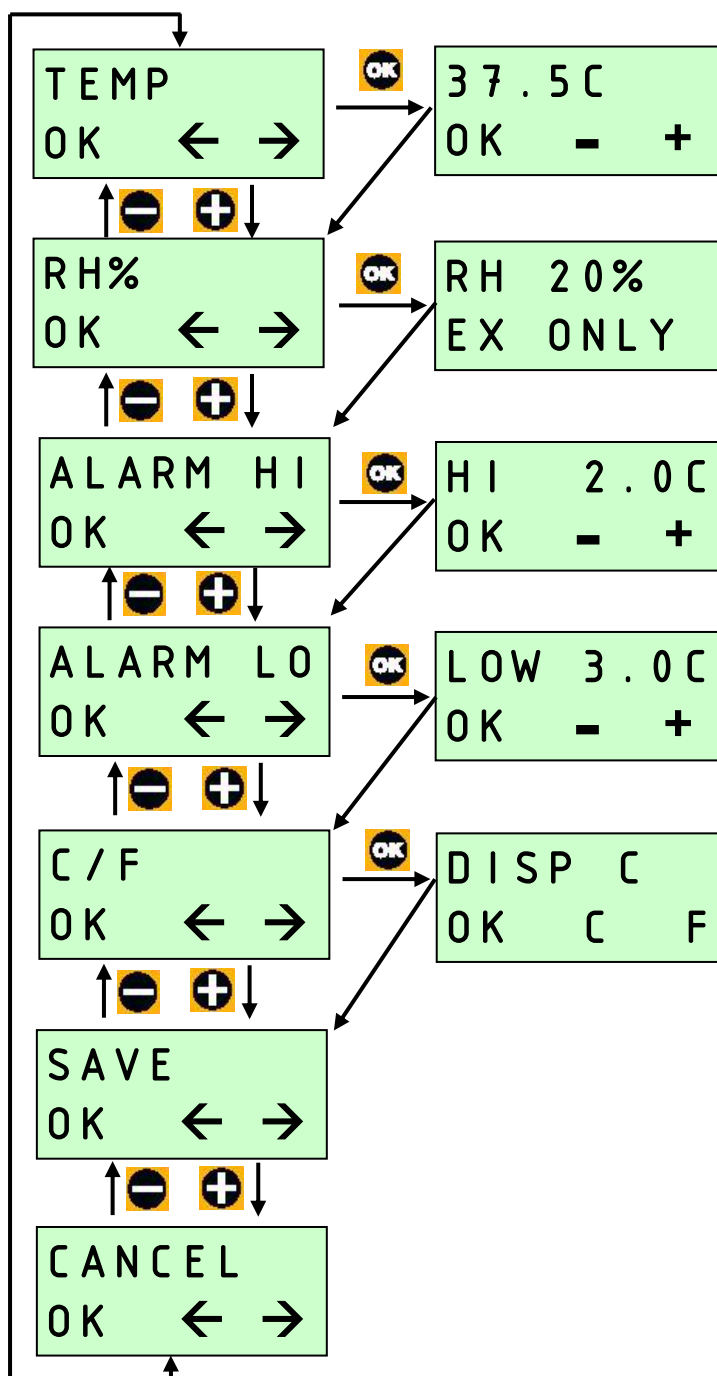

INCUBATION TEMPERATURE.
RANGE 20.0 – 40.0°C (68.0- 104.0°F).
DEFAULT 37.5°C (99.5°F).

RELATIVE HUMIDITY.
RANGE 20% – 80%.
DEFAULT 20%.
ONLY FOR EX VERSION WITH
ADVANCE HUMIDITY PUMP – SEE
SECTION 7.

HIGH TEMPERATURE ALARM. RANGE
1.0 – 5.0°C (1.8 – 9.0°F) ABOVE SET
INCUBATION TEMPERATURE.
DEFAULT 2.0°C (3.6°F).

LOW TEMPERATURE ALARM. RANGE
1.0 – 5.0°C (1.8 – 9.0°F) BELOW SET
INCUBATION TEMPERATURE.
DEFAULT 3.0°C (5.4°F).

CELSIUS / FAHRENHEIT DISPLAY.
SWITCHES ALL TEMPERATURE
FIGURES BETWEEN °C AND °F.
DEFAULT °C.

SAVE.
ALL CHANGES ARE SAVED. RETURN TO
NORMAL OPERATION SCREEN.

CANCEL.
ALL CHANGES ARE IGNORED. RETURN
TO NORMAL OPERATION SCREEN.

5 DIGITAL CONTROL SYSTEM

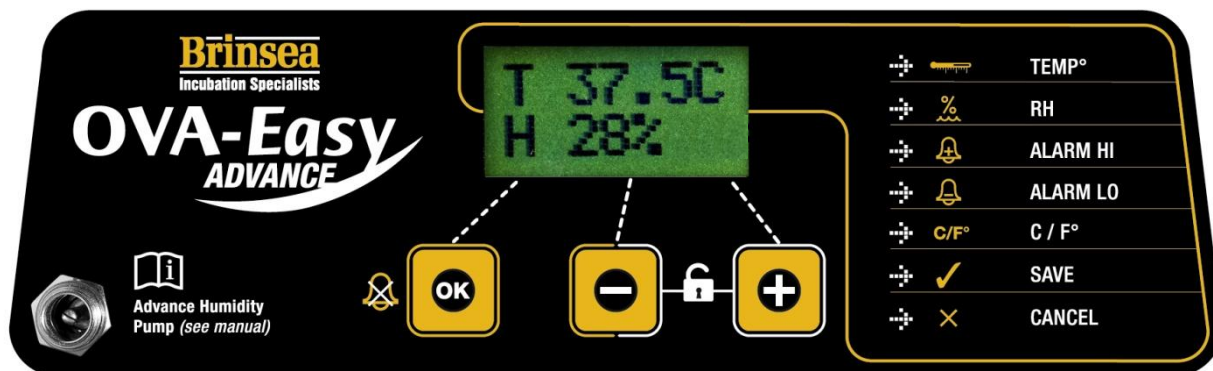

The Ova-Easy Advance control system utilises highly accurate, individually calibrated sensors for temperature and humidity. Be cautious of low cost analogue or digital thermometers and hygrometers when comparing them with the Hatcher display readings.

5.1 NORMAL OPERATION – Temperature and relative humidity are continuously displayed.

The asterisk "*" adjacent to the temperature reading shows when the heater power is on. When warming the asterisk will be continuously on, once warmed up the asterisk will slowly flash as the heater is pulsed to maintain the correct temperature.

When reducing the temperature setting the asterisk may go off, this is normal.

The asterisk "*" adjacent to the relative humidity display is only on when the pump control output is on (see section 7) and is only applicable when using the optional Brinsea Advance Humidity Management Module.

5.2 POWER LOSS DISPLAY – If power has been interrupted due to a power cut (or when first switching on) a "P" is shown flashing on the bottom line of the display. Press OK for 2 or more seconds to clear the indicator. If the reason for the power loss is not known check the power cable connections are secure.

Once the "P" indicator has been cleared, it is advisable to candle eggs a number of times to check for losses.

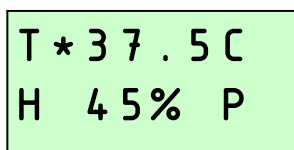

5.3 HIGH TEMPERATURE ALARM DISPLAY – If the measured temperature goes up by more than the figure in the ALARM HI screen, the alarm will sound immediately and "+T" will be displayed. Press OK to silence the alarm for 30 minutes.

If the high temperature problem rectifies itself the "+T" remains on the display to show this has happened. Press OK to clear the indicator. Check the Hatcher is not (and has not been) in direct sunlight or too near a heat source such as a room heater. It is advisable to candle eggs after this event to check for losses.

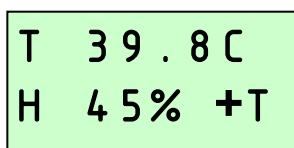

- 5.4 **LOW TEMPERATURE ALARM DISPLAY** – If the measured temperature goes down by more than the figure in the ALARM LO screen, after 60 minutes “-T” will be displayed and the alarm will sound. Press OK to silence the alarm for 30 minutes.

If the low temperature problem rectifies itself the “-T” remains on the display to show this has happened. Press OK to clear the indicator. Check the Hatcher is not (and has not been) in a cold draught or that the room temperature has dropped significantly. It is advisable to candle eggs after this event to check for losses.

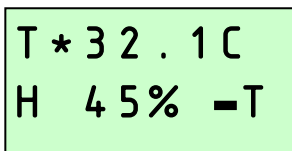

T * 32 . 1 C
H 45% -T

- 5.5 **LOW ROOM TEMPERATURE ALARM** – If the calculated room temperature remains too low for optimum results for more than 1 hour a warning is displayed “-RM” and an alarm will sound. Press OK to silence the alarm for 30 minutes.

If the low temperature problem rectifies itself the “-RM” remains on the display to show this has happened. Press OK to clear the indicator. Check the Hatcher is not (and has not been) in a cold draught or that the room temperature has dropped significantly. It is advisable to candle eggs after this event to check for losses.

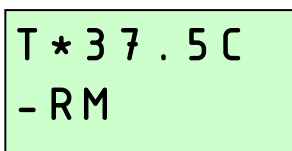

T * 37 . 5 C
- RM

- 5.6 **HIGH ROOM TEMPERATURE ALARM** – If the calculated room temperature remains too high for optimum results for more than 1 hour a warning is displayed “+RM” and an alarm will sound. Press OK to silence the alarm for 30 minutes.

If the high temperature problem rectifies itself the “+RM” remains on the display to show this has happened. Press OK to clear the indicator. Check the Hatcher is not (and has not been) in direct sunlight or too near a heat source such as a room heater. The eggs themselves create significant metabolic heating and may contribute to this if room temperature is high. It is advisable to candle eggs after this event to check for losses.

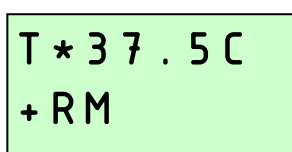

T * 37 . 5 C
+ RM

- 5.7 **CHANGING SETTINGS** – The Main Menu allows the various settings to be modified and saved. All changes are retained in the event of a power cut.

To access the Main Menu press the + and – buttons simultaneously to unlock the display. For full details of menu settings please refer to the guide on page 4.

6 Temperature

Stable and correct temperature is essential for good results. Adjust with care.

- 6.1 Note: your Hatcher may not be set to the correct temperature from the factory and the following procedure must be followed before setting eggs.
- 6.2 As the Hatcher warms up and approaches its control setting the heater on asterisk “*” will change from continuously on to flashing. Allow the Hatcher to stabilise for at least an hour before adjusting the temperature.
- 6.3 SETTING THE TEMPERATURE
- Press the - and + buttons simultaneously to unlock the Main Menu.
- Press OK to select the temperature screen and adjust as necessary using the + and – buttons.
- Press OK to return to the Main Menu and then scroll down to SAVE. Press OK to save the changes.
- When reducing temperature the asterisk may go out while the Hatcher cools – this is normal.
- 6.4 Refer to the digital temperature display to check temperature. The display shows the air temperature in increments of 0.1°. Adjust temperature with care – small differences have large effects on hatching performance.
- 6.5 The Display can be switched to show all temperature settings in degrees Fahrenheit. Press the - and + buttons simultaneously to unlock the Main Menu. Scroll to the C/F option and press OK to select the C/F display screen. Press the + button to select °F or the – button to select °C. Press OK to return to the Main Menu and then scroll down to Save. Press OK to save the changes.
- 6.6 The temperature for hatching may be set slightly lower than the incubation (setting) temperature and is generally less critical.

Recommended temperatures for Hatching:

Hens	36.0 – 37.5°C	96.8 – 99.5°F
Pheasant	36.0 – 37.5°C	96.8 – 99.5°F
Quail	36.0 – 37.5°C	96.8 – 99.5°F
Ducks	36.0 – 37.5°C	96.8 – 99.5°F
Geese	36.0 – 37.5°C	96.8 – 99.5°F

- 6.7 The Ova-Easy Advance range has built-in temperature alarms which warn of high or low incubation temperature and room temperature. See section 5 for details.

7 Humidity, Ventilation and Hatching.

- 7.1 Once the Hatcher has reached operating temperature the relative humidity level will gradually increase and stabilise. The generally accepted humidity level for hatching most species is 60%RH or higher. Avoid excessive humidity over 70% as this will condense as water on surfaces and may drip on the eggs. It also increases the time needed for chicks to dry. Open the vent to decrease the humidity level.
- 7.2 Two main factors affect incubation humidity: water evaporation within the cabinet (from the water pan and eggs) and levels of ventilation. The water content of the air being drawn through the Hatcher will also have an effect.
- 7.3 The humidity level can be controlled manually using the ventilation slider. Avoid opening the door as it will take some time for the humidity level to stabilise again.

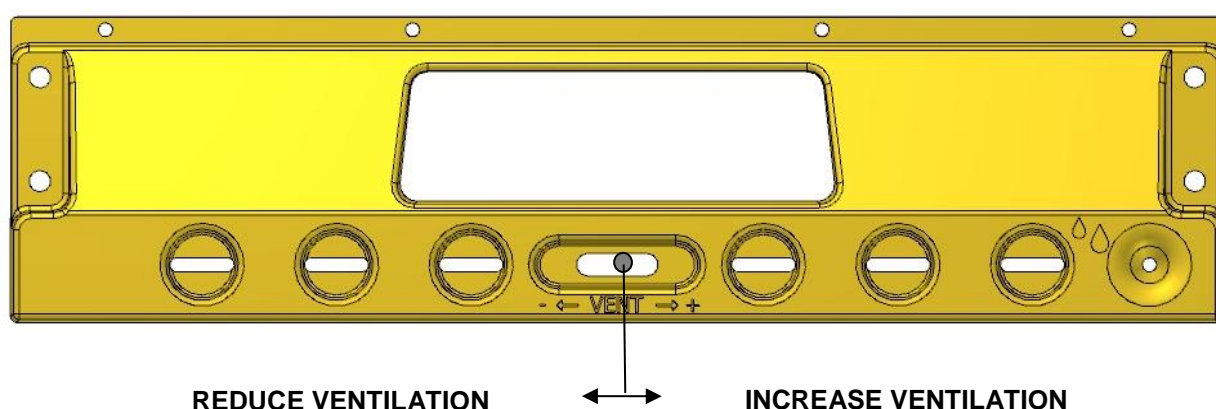

- 7.4 Because of the short duration involved water/weight loss will not be significantly affected. High humidity is necessary to prevent membranes drying and hardening before the hatch fully emerges. Humidity will naturally increase as the first eggs begin to hatch and internal membranes begin to dry. This effect is in addition to the water evaporation from the evaporation pan.
- 7.5 The Brinsea Advance Humidity Pump is available as an option on the Ova-Easy Advance incubators. The incubator digital control system not only reads the humidity in the incubator but it provides a control signal to operate the water pump and accurately maintain the humidity level at the desired level automatically. Visit www.brinsea.co.uk for more information.

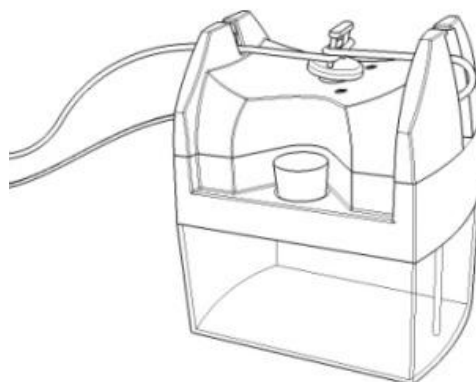

Advance Humidity Pump.

- 7.6 To assemble the hatching trays place a white plastic peg in each of the four corner sockets on an Ova-Easy universal tray as shown below. The wide end of the peg should make a push fit into the socket. Another universal tray may then be placed upside-down over the narrow end of the pegs to form a secure lid over the hatching eggs. When the lid is removed the pegs will stay fixed in the bottom tray.

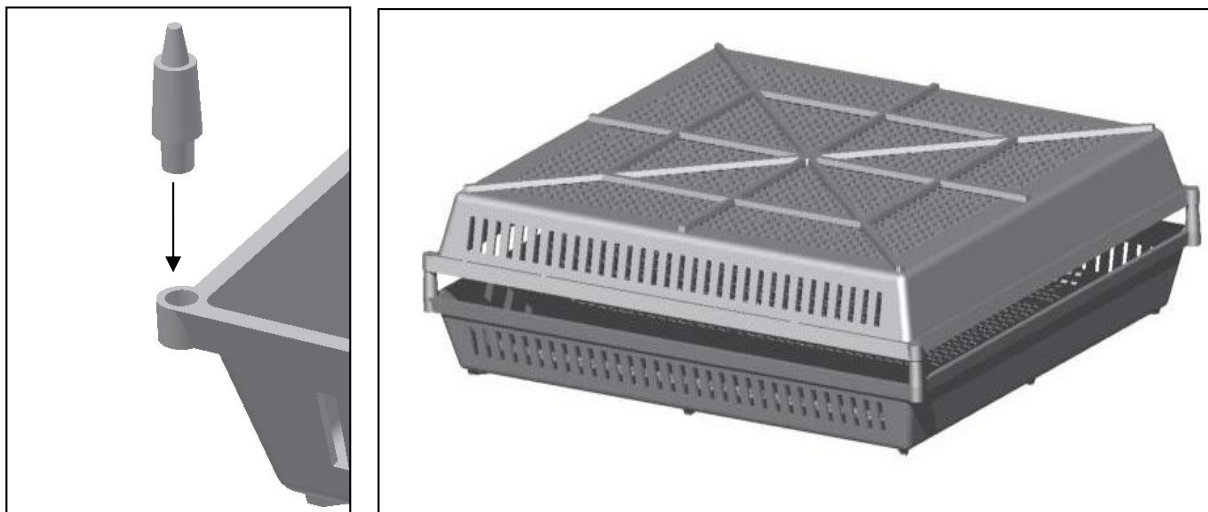

- 7.7 Do not place paper towels or other objects in the bottom of the trays as this will impede flow of air. The eggs are placed directly in the bottom of the tray.
- 7.8 During hatching the high humidity levels will fall dramatically when the door is opened and will take some time to build up. Resist the temptation to open the door frequently – leave for at least 6 hours between inspections.
- 7.9 When most eggs have hatched (12 to 48 hours) move the hatchlings to a brooder.

8 Cleaning Up

IMPORTANT:

DISCONNECT THE HATCHER FROM THE MAINS POWER SUPPLY DURING CLEANING.

ENSURE THAT ALL ELECTRICAL PARTS ARE KEPT DRY.

NEVER WASH THE TRAYS, INSULATED PANELS, FASCIA OR EVAPORATION TRAY PARTS WITH LIQUIDS OVER 50°C (120°F). DO NOT USE A DISHWASHER TO CLEAN THESE PARTS.

NEVER ALLOW CLEANING WATER TO COME INTO CONTACT WITH THE TEMPERATURE AND HUMIDITY SENSOR. THIS IS SUSPENDED INSIDE THE AIR OUTLET VENTS AT THE FRONT OF THE HATCHER. CONTAMINATION MAY DAMAGE THE SENSOR.

- 8.1 Following each hatch remove and wash the egg trays in Incubation Disinfectant Solution. Wipe all other internal surfaces with a soft cloth soaked in the solution. Ensure that the instructions supplied with the fluid are followed. Dust and fluff may be removed from the fan guard area with a soft brush.
- 8.2 The exterior of the Hatcher may be cleaned with a damp cloth. Avoid allowing any moisture to get inside the top electrical housing or electrical connector at rear.
- 8.3 Always clean the Hatcher before storage and ensure that the unit is totally dry inside and out.

9 Troubleshooting

- 9.1 Poor hatching results are frustrating and can be caused by a large number of factors. The most common are given below. Brinsea Products will not be held responsible for loss of eggs or chicks under any circumstances. A wealth of advice and information is available on our website:- www.brinsea.co.uk
- 9.2 Gather as much information from the hatching results as possible to enable the problem to be analysed in detail. Record dates that eggs are set, incubator settings, dates of hatches, weight losses and the number and condition of hatchlings. Candle or break open unhatched eggs to estimate the extent of embryo development. The Brinsea OvaView and High Intensity OvaView candling lamps are available from your dealer.
- 9.3 Many hatching problems are associated with incorrect humidity during incubation. Consider upgrading to EX specification to give better control of humidity. Go to www.brinsea.co.uk for details.

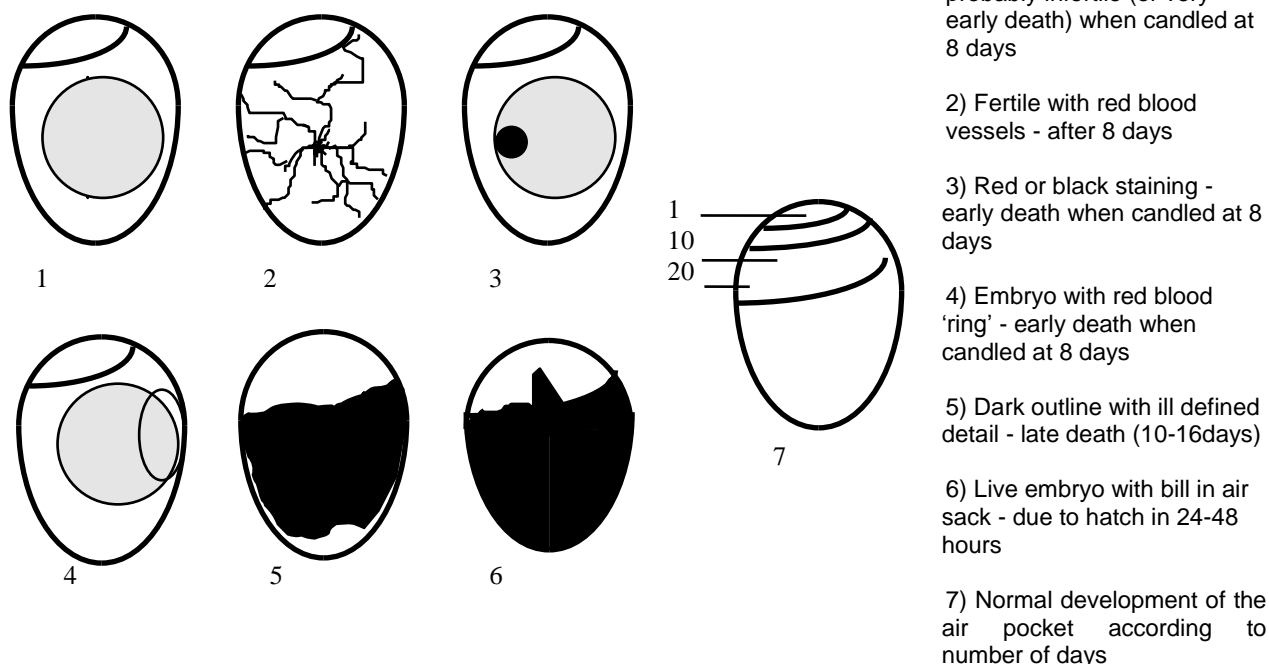

1) Clear when candled - probably infertile (or very early death) when candled at 8 days

2) Fertile with red blood vessels - after 8 days

3) Red or black staining - early death when candled at 8 days

4) Embryo with red blood 'ring' - early death when candled at 8 days

5) Dark outline with ill defined detail - late death (10-16days)

6) Live embryo with bill in air sack - due to hatch in 24-48 hours

7) Normal development of the air pocket according to number of days

9.4 General guides:

Observation	Likely Cause(s)	Solution(s)
No chicks hatch	Infertility, infection, drastically incorrect incubation settings, parent ill health.	Check egg viability – are similar eggs hatching naturally. Disinfect the incubator. Check incubator settings and procedures – particularly temperature.
Chicks hatch earlier than expected, deformities.	Incubation temperature too high	Reduce incubation temperature slightly 0.5°C (1°F)
Chicks hatch later than expected	Incubation temperature too low	Raise incubation temperature slightly 0.5°C (1°F)
Hatch dates widely spread	Different rates of development due to different storage times, incubation temperature variation.	Limit egg storage times. Check for incubation temperature variation – sunlight, large room variation etc.
Late stage 'death in shell'	Incorrect humidity, probably too high.	Try reducing average humidity levels (but see section 6 above)
Generally poor results	Incorrect incubation settings, poor parent bird health, inadequate egg turning,	Improve parent bird health, check all incubation settings, analyse egg weight loss to confirm humidity correct, check turning working correctly.

10 Servicing and Calibration

IMPORTANT: THE HEATER AND CONTROL SYSTEM ARE AT MAINS VOLTAGE. NEVER ATTEMPT ANY KIND OR FORM OF SERVICING UNLESS THE MACHINE IS DISCONNECTED FROM THE MAINS ELECTRICITY SUPPLY. RISK OF ELECTRIC SHOCK!

- 10.1 Under certain conditions it is possible that condensation may form on the inner walls. The presence of water gathering at the base of the Hatcher does not affect the performance of your Hatcher and does not pose an electrical hazard.
- 10.2 In case of a failure first check that the mains power supply is working and that the mains cable connector is fully engaged in the socket on the rear panel. The digital control system may be reset to the original factory defaults by connecting the power supply while holding the OK button. Check temperature calibration after resetting to defaults.
- 10.3 If the problem persists contact your distributor or Brinsea Products Service Dept.
- 10.4 The functional parts of the Ova-Easy Advance Series II incubators are modular and parts are available and are readily exchanged by a suitably qualified person equipped with basic tools. Fitting instructions are supplied with replacement parts.
- 10.5 The digital temperature and humidity display is individually calibrated during manufacture but may be re-calibrated if required. It is NOT RECOMMENDED that this procedure is carried out by the user.

BE CAUTIOUS OF LOW COST ANALOGUE OR DIGITAL THERMOMETERS AND HYGROMETERS.

BRINSEA PRODUCTS LTD USES SOPHISTICATED EQUIPMENT TRACEABLE TO INTERNATIONAL REFERENCE STANDARDS.

To access the Calibration Menu press all three buttons simultaneously to unlock the display.

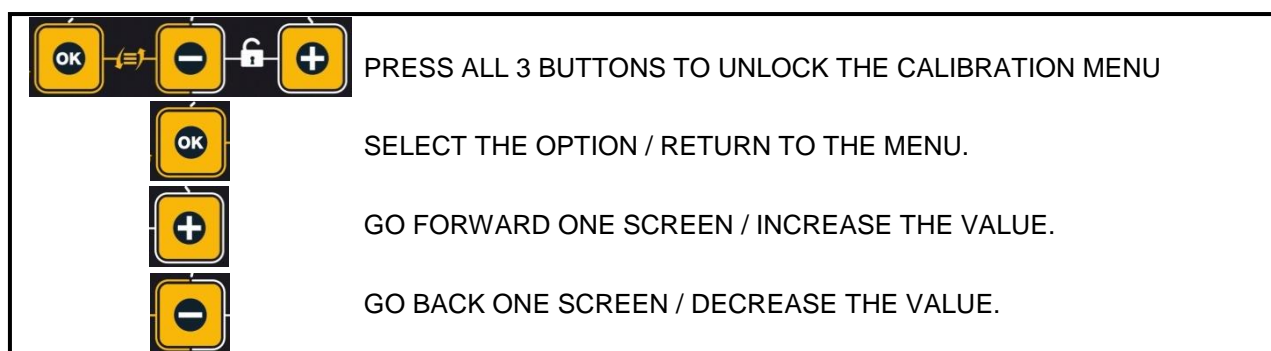

CALIBRATION MENU

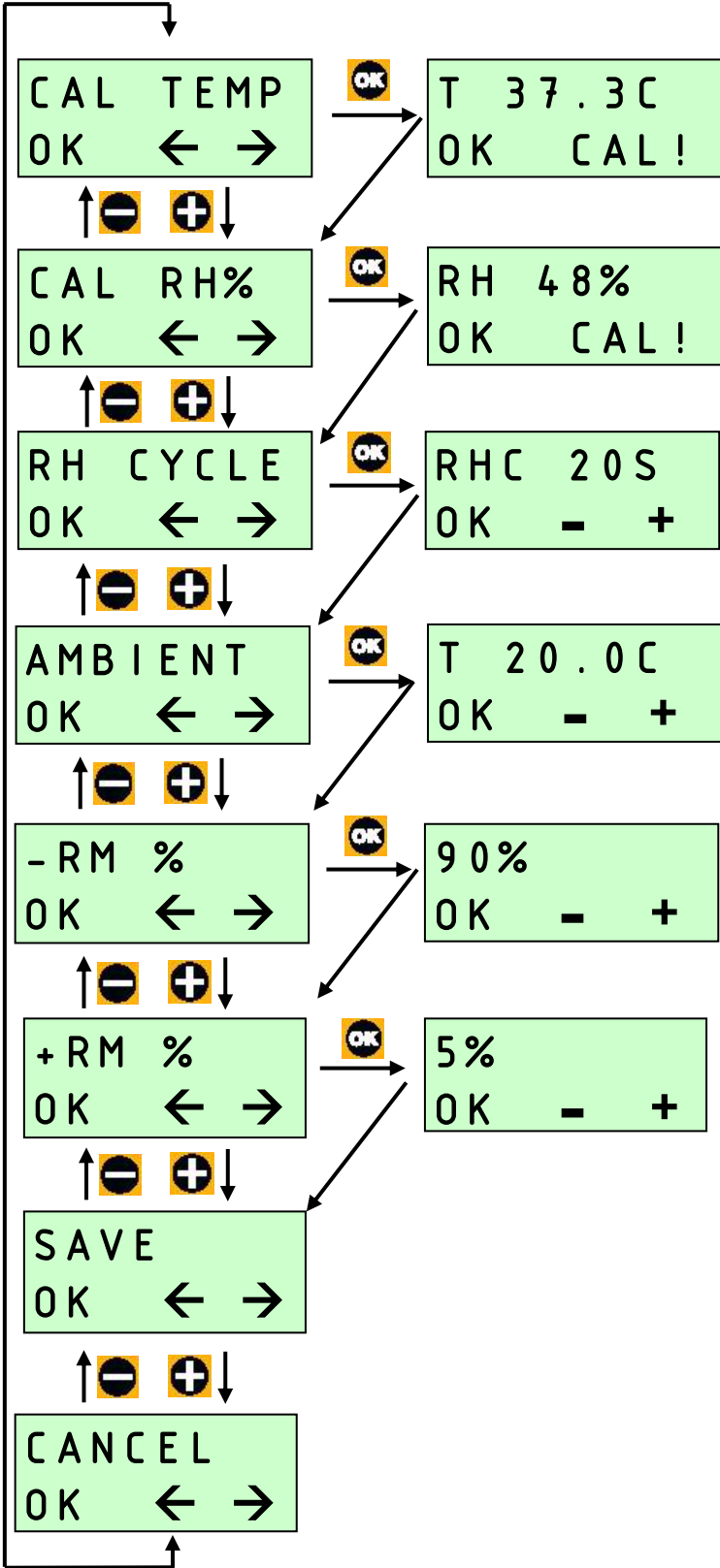

CALIBRATE THERMOMETER.
TAKE READINGS AT 30mm ABOVE THE CENTRE OF EACH EGG TRAY AND CALCULATE THE AVERAGE.

CALIBRATE HYGROMETER.
PLACE HYGROMETER IN CENTRE WITH NO WATER IN THE WATER PAN.

HUMIDITY PUMP CYCLE TIME.
ONLY APPLICABLE WHEN USED WITH THE BRINSEA ADVANCE HUMIDITY PUMP.

AMBIENT TEMPERATURE COMPENSATION.
AMBIENT TEMPERATURE USED IN HEATER CONTROL ALGORITHM. ONLY ADJUST IF DISPLAY VARIES BY MORE THAN +/- 0.2°C.

LOW ROOM TEMPERATURE ALARM ADJUSTMENT.
SETS HEATING THHRESHOLD FOR LOW ROOM TEMPERATURE ALARM.

HIGH ROOM TEMPERATURE ALARM ADJUSTMENT.
SETS HEATING THRESHOLD FOR HIGH ROOM TEMPERATURE ALARM.

11 Specification

Maximum Approximate Capacities:

Quail	500
Pheasant	274
Hen	432
Duck	140
Goose	72

Dimensions:

470 x 420 x 800mm (18.5" x 16.5" x 31.5") HxWxD

Weight:

24Kg (53lbs)

Power Consumption:

Maximum	200 Watts
(typical average)	100 Watts

Electrical Supply: 230v 50Hz or 110V 60Hz (as ordered)

Brinsea Products Ltd, Station Road, Sandford, N. Somerset, BS25 5RA, England
Tel 0845 226 0120, Fax 01934 820250, email sales@brinsea.co.uk

Declaration of Conformity

We: BRINSEA PRODUCTS LTD.
Station Road
Sandford
North Somerset
BS25 5RA

Declare under our sole responsibility the products:

Egg Incubators:

Ova-Easy Advance Series 2 Hatcher (Serial numbers MJ4923x/xxxxxxxxx, MJ4933x/xxxxxxxxx)

to which this declaration relates are in conformity with the following EU Directives:

2006/42/EC Machinery Directive

2004/108/EC Electromagnetic Compatibility Directive

2011/65/EU Restriction on the use of Certain Hazardous Substances in Electrical and Electronic Equipment Regulations

The relevant sections of the following Standards have been used:

EN 60335-1:2012

EN 60335-2-71:2003+A1:2007

EN 55014-1:2006+A2:2011

EN 55014-2:1997+A2:2008

EN 50581:2012

The technical documentation for the products is available from the above address.

Authorised Representative: Ian Pearce, Managing Director

Signature:

Date of Issue: 16/04/2013

Place of Issue: Station Road, Sandford, North Somerset, BS25 5RA, United Kingdom.