

Love of life begins with "Rcom"

REPTILE 90

Ver. 4

DIGITAL REPTILE INCUBATOR USER'S MANUAL

REPTILE MAX 90



Rcom



How to use Rcom Reptile MAX 90

1. Introduction	
(1) Rcom Reptile 90 Introduction	3 ~ 6
(2) Safety precautions	
(3) Identification of Parts and Composition	
(4) Name & Function of Operation Parts	
2. Before use	
(1) What is an Incubation Room?	7
(2) How to Assemble	
3. Incubation	
(1) Incubation Installation / Incubation Start	8 ~ 10
(2) Incubation Termination	
4. Function Settings	
(1) Return to Factory Setting	10 ~ 13
(2) Temperature / Humidity Setting	
(3) How to turn ON/OFF Humidification function	
(4) Abnormal high, Low temperature alarm setting method	
(5) Daily Temperature Range(D.T.G) setting method	
(6) How to change Centigrade & Fahrenheit	
5. How to Clean	
(1) Disassembling and Cleaning the Incubator	14
6. Understanding	
(1) Recommended temperature and humidity table by reptile during incubation	15
7. Product Information	
(1) Troubleshooting	16 ~ 18
(2) Specification	

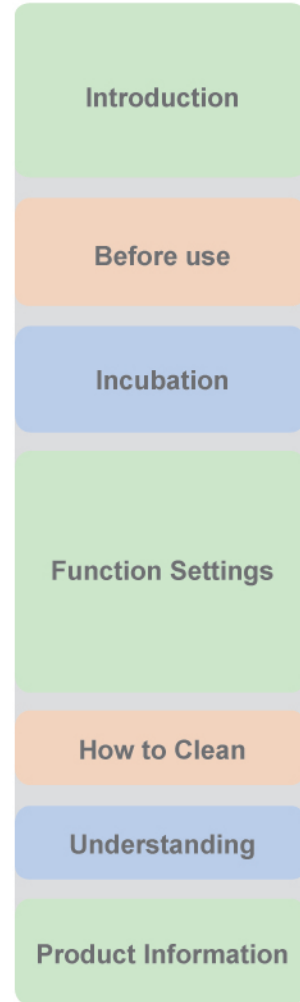

⚠ The result of Hatching and Brooding can be changed by a large numbers of factors. Autoelex Co., Ltd. & our distributors will not take any responsibility for 'Loss of eggs or pet/animal lives' under any circumstances such as 'Hatching/Brooding failures', 'User's carelessness', 'Personal (un-certificated) conversion / alteration', 'Arbitrary using out of the machine's purpose', 'Electric power failure', or 'Malfunctioning'. Please be sure that the machine works without any problem before placing Eggs or Pets(Animals). Also, we strongly recommend you to read the User's Manual carefully to minimize of any failure.

Mark Explanation

- Caution :** Caution mark against a fault that can cause damage, trouble, or failure of incubation.
- Prohibited.
- Do not disassemble.
- Do not touch.
- It is necessary to keep.
- Remove the power cord from outlet.
- Ground Connection for preventing electric shock.

Tip : References or useful suggestions in using Rcom product

⚠ CAUTION Warning of actions which may be dangerous or cause damage to the incubator.

Rcom Reptile 90

First of all, we would like to express our deep appreciation for all the customers who purchased Rcom Reptile Incubator. Rcom Reptile Incubator was designed to be used easily and conveniently by the newest digital control method for controlling optimal incubation environment automatically, however, in order to get the best incubation result, at first, it is very important for users to have some incubation knowledge and right machine operation method. Therefore, before using incubator, be sure to read instruction manual. Rcom Reptile Incubator provides the best incubation environment, however, it is necessary for users to observe and adjust each environment necessary for incubation including egg kind, temperature and humidity management by incubation date, surrounding conditions of incubator, and this product was made it possible to make the best setting for all the environments necessary for incubation.

Features of Rcom Reptile 90

[Main Function]

- * Superior design with convenient operation
- * Optimum air circulation technique with 3 high reliability BLDC fans
- * Automatic Temp. & Humidity setting and control
- * FND display with incubation information
- * Body locking device
- * Water supplement alarm function
- * Antiblastic Humidification method by heating water, which discourages bacterial growth
- * Double-glazed view window for minimizing the influence of outside temperature
- * Enhanced reliability by applying Swiss's Sensirion's 3rd generation temperature & humidity sensor
- * Powerful SMPS application for stable power supply
- * The function of diurnal range (D.T.G)



Daily temperature range function means as follows : It is a function artificially making the highest time zone of temperature by sun at the natural condition, and it is a function that can raise the incubation success rate of reptile by the optimal incubation environment by raising temperature at the fixed time zone.

[Safety Function]

- * Alarm and display function of abnormal incubator temperature caused by sudden fluctuation of ambient temperature
- * Incubation data memory function and power outage notification function in case of power failure
- * Circulation fan cover for safety and electric safety cut-out switch on the upper main body for safety
- * Heater supporter designed for heater tension control and its safety
- * Safety cover applied for protecting humidification unit
- * Humidification unit durability improved by water proof BLDC fan
- * Alarm function when water needs replenishing

[Easy Function]

- * No need of separate humidification unit as it included in main body
- * Centigrade and Fahrenheit changing function
- * Easy attachment and detachment of double-glazed viewing window
- * Tray for incubation for exclusive use by reptile
- * Bottom body designed for easy cleaning
- * Micro chip with optimum incubation conditions according to the species of reptiles, for incubation beginners

Electrical hazards

CAUTION Be careful the details below when you use.



Do not use a damaged power cord or loose outlet.
▶ Risk of electric shock or fire.

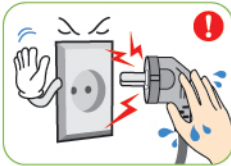

Do not pull the cord when taking out the power cord, and keep wet hands away from connecting plug.
▶ Risk of electric shock or fire.



Never pull the plug out of the outlet during the incubation period.
▶ Incubation will be interrupted.



Do not twist or crush electric cord.
▶ Risk of electric shock or fire.

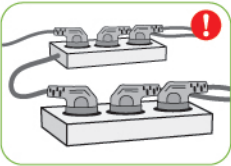

Do not insert multiple connecting plugs in an outlet.
▶ Risk of fire or electrical overload.

Setting Cautions

CAUTION Be careful the details below when you use.



Do not install in dusty or dirty environment.
▶ Risk of damage or fire within the incubator.



Do not install under the direct sunlight.
▶ Risk of fire or interference with the incubation process.



Do not install in moist or humid environment.
▶ Risk of fire or electric shock.



Do not install in excessively cold or hot conditions, cigarette smoke, etc.
▶ Risk of interference with the incubation process.



Do not use any other non-standard parts except those provided.
▶ Risk of damage or hatching failure.



Do not cover the ventilating opening.
▶ Inner temperature can rise, interrupting incubation.

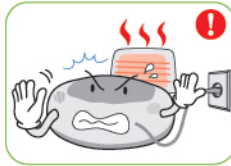

Install away from heat sources.
▶ Risk of damage to the incubator case and interference with the incubation process.



Ensure that the incubator is installed on a stable surface away from edges.
▶ Risk of damage to incubator and eggs and user from accidental knocks or drops.



Do not turn the incubator upside down.
▶ Water will pour out of the incubator, and view window can be dropped or damaged.

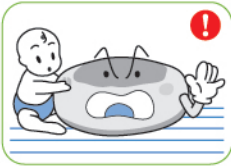

Children should be supervised to ensure that they do not play with the appliance.



Do not disassemble or modify the incubator in any way.
▶ Risk if electric shock or fire.



Please ensure that no small objects get into the holes on the incubator.
▶ Risk of electric shock or fire.

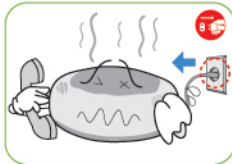

If the incubator sounds strange or emits smoke contact your service center.
▶ Risk of electric shock or fire.



Clean the incubator thoroughly before storing.

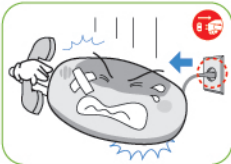

If the incubator requires repair disconnect from the power supply and please contact to your service center.

Cleaning Cautions

CAUTION Be sure to disconnect the electric cord from the outlet before cleaning.

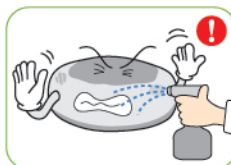

Do not spray cleanser directly on the incubator surface.



Clean the incubator by a soft cloth with a neutral detergent.



Brush away dust on the plug with a dry cloth.



Do not use chemicals like wax, benzene, alcohol, thinner, aromatic, or lubricant, etc.



For special cleaning of inner part per year, contact to the service center.
▶ If you don't clean the inside of incubator for a long time, dust can cause some trouble or a fire.

Identification of Parts

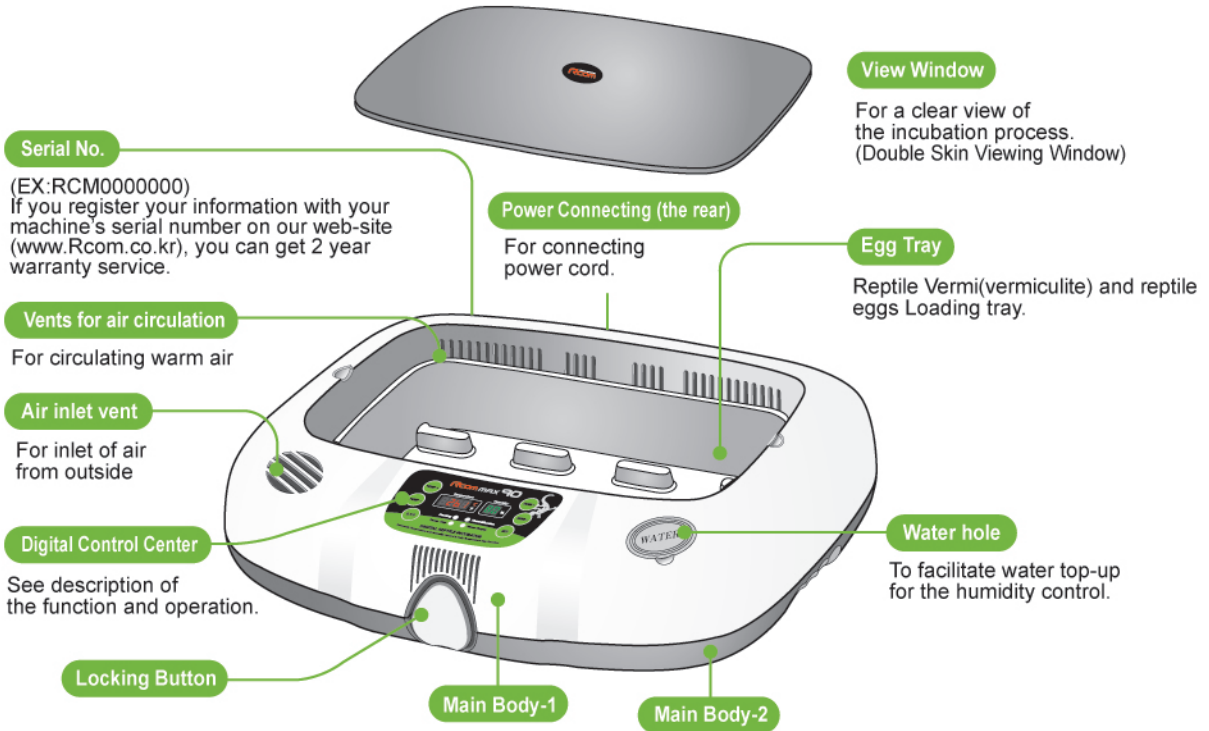

Basic Components

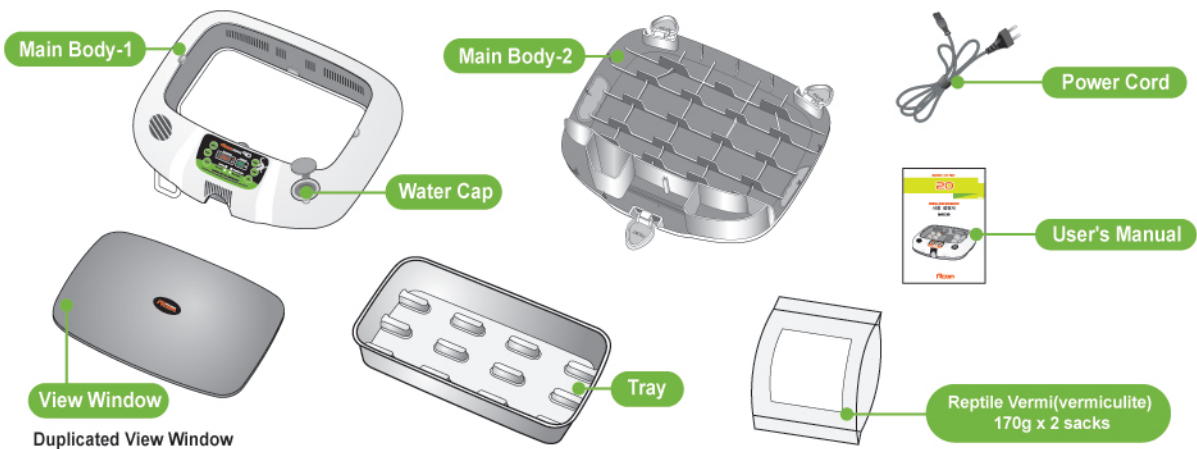

Name & Function of Operation Parts

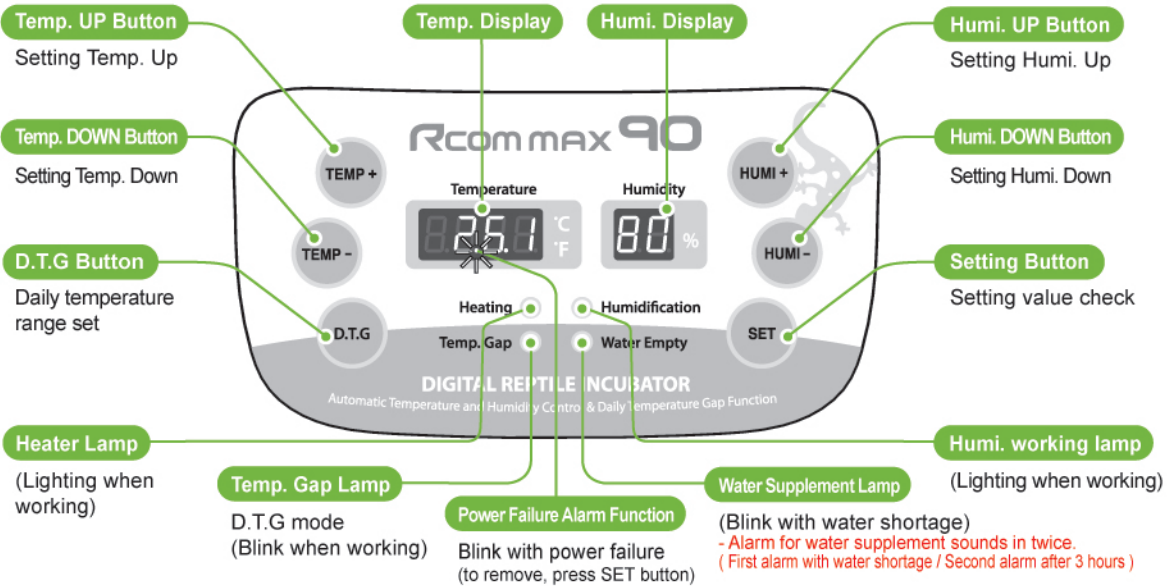

What's 'Temperature & Humidity Setting'?

This is that you set up temp. & humi. As you want to have inside of the machine.

[Function Operation & Explanation]

* If you want to change setting value, keep pressing "SET" button and change the value.

Function	How to Operate	Explanation
Temp. Setting	SET HOLD ▶ TEMP+ OR TEMP-	Setting of needed temp.
Humidity Setting	SET HOLD ▶ HUMI+ OR HUMI-	Setting of needed humidity.
Daily Temp. Gap (D.T.G) set	SET HOLD ▶ D.T.G	D.T.G ON / D.T.G OFF (one time a day for 3 hours + 1.5°C operation)
Changing Cels. & Fahr.	TEMP+ + TEMP- HOLD ▶ CA ▶ SET	Changing Cels. & Fahr.
Initialization (Factory setting)	SET HOLD + POWER IN ▶ rSt	Initialization
How to OFF Humidification Function	SET + HUMI- ▶ below 40%	In case of incubation at low humidity

What is an Incubation Room?

Incubation room? It means the place where the incubator is installed and operated, and as it has much effect on incubation rate according to the environment of incubation room, it is good to install incubator at the place where there is little noise and vibration in the vicinity and the temperature range isn't severe in the temperature of 22~25°C (71.6~77°F). In particular, as there are many cases that the temperature falls rapidly in the nighttime differently from the daytime, it is necessary to check certainly, and during daytime, incubator must not be exposed directly to the sunlight.

How to Assemble

When installing reptile incubator, in case that the temperature of incubation room is higher than its set temperature, the temperature control of incubator inside may not be done normally. The set temperature of incubation room should be around 4°C (7.2°F) lower than incubator set temperature.

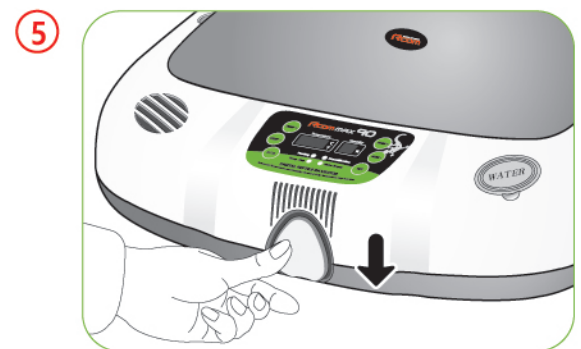

▶ Lock the three locking buttons at the front and rear of the incubator.

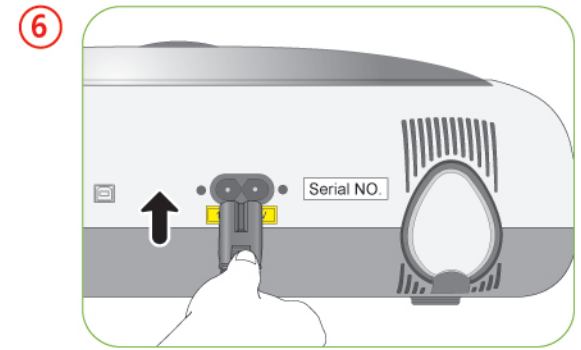

▶ Insert the power cord in the socket at the back of the main body.

▶ Register Serial NO. in the back of main body (up). Free warranty period is extended to 2 years.(See 17 page)

Preparation for Incubation

⚠ Before inserting eggs, please start incubation after checking if all functions work without any problem by operating incubator sufficiently.

Environment condition of incubation room for installing reptile incubator.
(temperature : 22~25°C (71.6~77°F) / humidity : RH 30~50%)

▶ It is for making water supply be smooth when beginning incubation, and fill water for humidification in the water tank located on [Fig-1] ㉠, ㉡ of downside main body.

▶ See [Fig-7] for ㉢ of [Fig.-1].

⚠ In case of moving with water filled, as it may cause a breakdown, fill water after installing it at the place where you want to incubate.

▶ Heater part for humidification in the upper side of main body [Fig. 2] should be submerged in the water of the inside of water tank in case of assembling with the lower part of main body. Please be sure to check and close sight glass and plug in to operate for about 30~40 minutes.

Tip Please be careful not to give any heavy power or shock on the heater part for humidification in the upper side of main body as it may be a cause of breakdown. Some foreign substance is created on the heater part after use, however, there isn't any problem caused of it. (See cleaning method)

▶ In case of using without inserting water, it is necessary to turn off its humidifying function.
(See humidifying function OFF method)

▶ Put 2 bags of reptile vermiculite and 1200cc of water into tray and mix. [Fig-3]

Tip It is possible to purchase a vermiculite for reptile incubation separately.

▶ It has an automatic humidifying function, however, as the inside humidity of incubator depends on the water quantity mixed with reptile vermiculite, please be sure to check the incubation environment of reptile.

⚠ In case that the reptile vermiculite was completely dried, it may be in a very dry state by absorbing the surrounding humidity of incubator inside and egg. It is good to start after understanding the required environment for each reptile kind and making previous test if incubation environment is proper to minimize incubation failure.

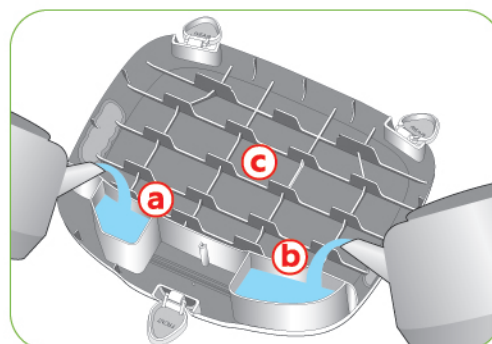

[Fig-1]



[Fig-2]

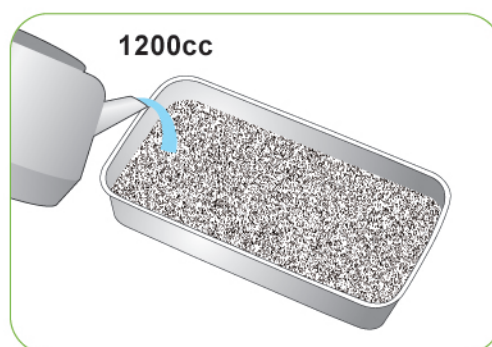

[Fig-3]

! It is good for reptile vermi not to be reused after incubation. Incubation rate falls notably because of Bacteria contamination. [It is possible to purchase at the place you purchased.]

▶ Bury about 1/2 of egg to be incubated in reptile vermin to fix egg. [Fig-4] (During incubation, check the state of eggs at least once a week and remove unfertilized eggs, growth-stopped eggs and moldy eggs.)

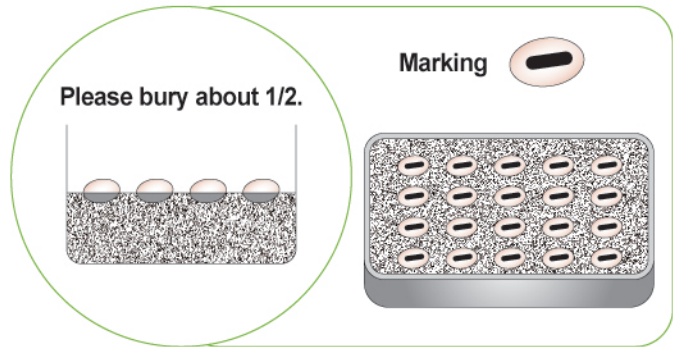

[Fig-4]

Tip When reptile laid eggs, they should be moved to the incubator as the first direction when laying eggs was. It is convenient to making a marking on the egg in order for them not to be changed.

▶ Set the environment of egg to be incubated to install the prepared tray in the inside of incubator and close the lid of sight glass tightly.

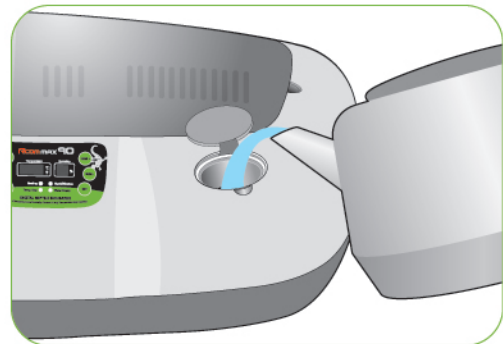

[Fig-5]

! In case that sight glass and water cap weren't closed completely, temperature and humidity aren't normally operated. Therefore, please be careful.

▶ Check water for humidification every day and makeup water as seen in [Fig.-5]. Then, it is necessary to stop it when the Styrofoam ball in the inside comes up.

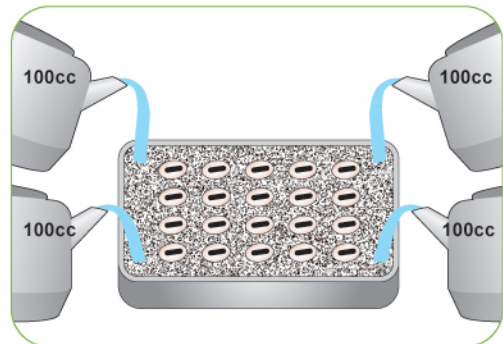

[Fig-6]

! Even though the marking humidity of incubator is normal, it is necessary to check the humidification state of vermiculite at least once a week and check the state of vermiculite once a month to makeup 400cc of water as seen in [Fig.-6].

▶ In case that the humidity of incubator inside isn't controlled into high humidity of RH 90~95% according to the environment of incubation room, pour 75cc of water for humidification on each edge of 4 tray sides for incubation where without any egg meddle [Fig.-6] and pour 1000cc of water on © of [Fig-7] main body(bottom).

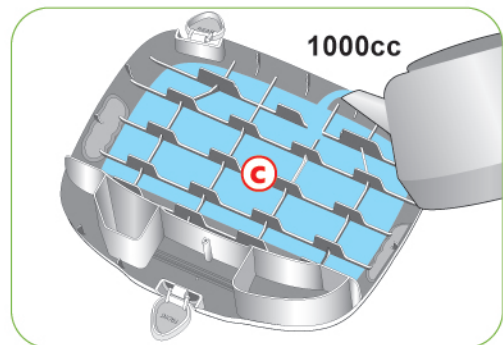

[Fig-7]

! In case of humidifying inside humidity over RH 60%, be sure to fill main body(bottom) of [Fig.-7] with 1000cc of water, and in case of setting incubation humidity into less than RH 60%, it isn't necessary to pour water on the bottom. In case of incubating at low humidity, water may be created naturally on the bottom by dew condensation. Therefore, it is necessary to check sometimes to remove it.

How to Start Incubation

- ▶ Connect power cord of incubator to start incubation into the temperature and humidity set in the past.
[In case of initial shipment, temperature 26.1°C (78.98°F), humidity RH 80%]
- ▶ Set proper temperature and humidity of species to be incubated to start incubation. It is necessary to pass some period to be stabilized into set temperature and humidity.

Tip There can be some odor the first time you use incubator, which is normal.

Tip Power Failure Notification : When firstly input power, or power failure during incubation, second dot "." of temp. display is blink with alarm. Press SET to remove.

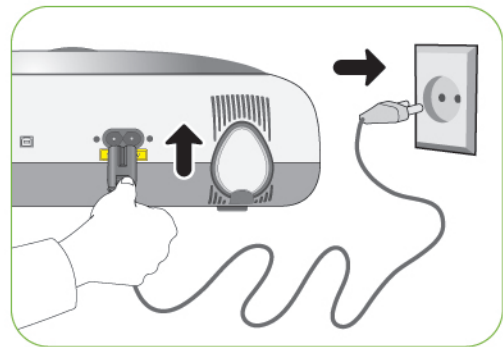

※ The artificial intelligence system memorizes and classifies ambient conditions for keeping optimum temperature, and temperature can move up slowly at the first stage.

Incubation Termination

- ▶ After all eggs are hatched, you should REMOVE the power cord for incubation termination.
(The incubator has no separate power switch.)
- ▶ In case of neglecting it after turning off incubator during incubating at high humidity, the water leaving in the inside evaporates and may create water drops on the FND window and control equipment. In order to prevent this, separate the up and down of main body to dry it. (it may be possible to operate incubator for 1~2 hours and dry its inside after removing the water for humidification of incubator inside.)

Return to Factory Setting

- ▶ It is for returning to the factory default setting.
- ▶ It is for initializing the incubator setting or calibration to the factory settings when you handle the incubator improperly so that the value has changed. Unplug the power supply and hold SET button and re-plug the power supply as shown on picture. Then, rSt will show on the display, and the incubator will be initialized to factory setting.

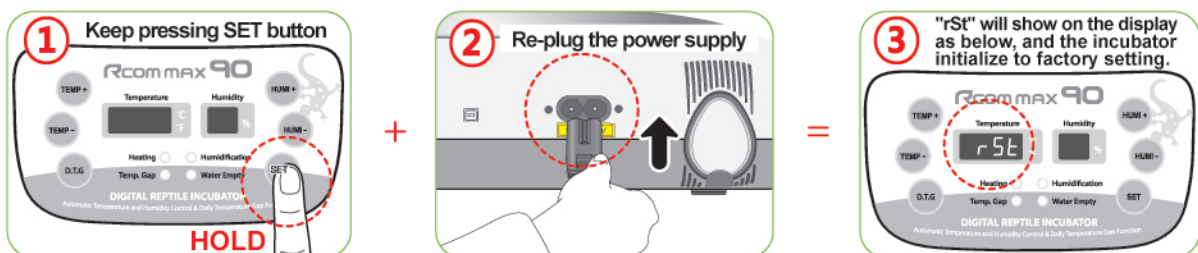

Temperature Setting

- ▶ Press **TEMP+** button or **TEMP-** button pressing **SET** button to adjust into wanted temperature. Take hands off from SET button to complete temperature setting and display the temperature of present incubator inside.

Tip In case of installing incubator at the place where direct light lights or its surrounding temperature is too low, it may be higher or lower than set temperature.

- ▶ Press **SET** button to display set temperature and humidity and take hands off to display present temperature and humidity of incubator inside.

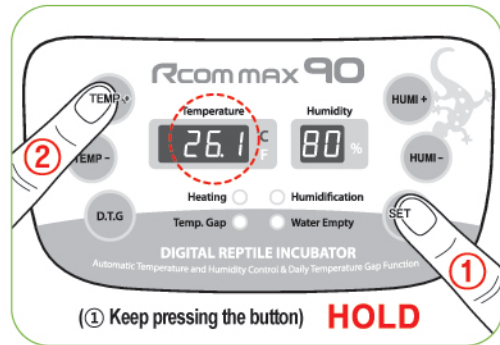

Humidity Setting

- ▶ Press **HUMI+** button or **HUMI-** button pressing **SET** button to adjust into wanted humidity. Take hands off from SET button to complete humidity setting and display the present humidity of incubator inside.

Tip The temperature or humidity of incubator is out of set range according to the surrounding environment (incubation room), there may be some difference.

! Temperature and humidity is optimized when Rcom products are released. We do not recommend customers to recalibrate by their own. If you need to recalibrate, please visit our website (www.Rcom.co.kr→Download→Manual) or ask purchase place. Because of low price thermometers and hygrometers are not accurate, we recommend you to use special calibrated thermo-hydrometer. (Poultry only thermo-hydrometer: check Rcom website)

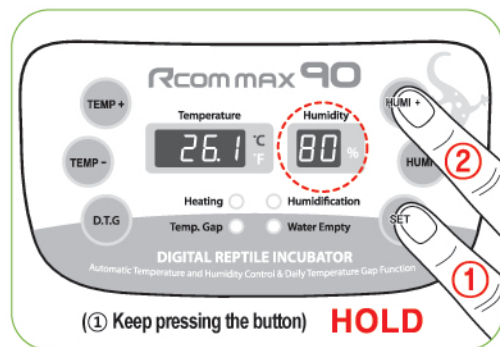

How to Turn ON/OFF Humidification Function

- ▶ Continue to press **HUMI-** button pressing **SET** button until "OFF" is displayed to turn off humidifying function.
- ▶ Press **HUMI+** button pressing **SET** button to set humidity into over RH 40%. Then, its humidifying function is on.

! In case of using without putting water for humidification in or incubating at low humidity of less than RH 40%, it is necessary to stop humidifying function. In case of not supplying water for humidification turning on humidifying equipment, the humidifying unit part is damaged or the lifespan of part is shorten noticeably. Be sure to turn OFF humidifying function equipment.

4. Function Settings

(4) Abnormal high, Low temperature alarm setting method
 (5) Daily Temperature Range(D.T.G) setting method
 (6) How to change Centigrade & Fahrenheit

REPTILE 90

Abnormal high, Low temperature alarm setting method

- ▶ What is abnormal alarm function? It is an alarm function notifying it to user in case that the temperature of incubator inside raised or decreased abnormally.

※ How to Set



- * Max. abnormal temp. alarm limit [0.0 ~ 5.0°C (0 ~ 9°F) Default Setting : 0°C]
- * Min. abnormal temp. alarm limit [0.0 ~ -5.0°C (0 ~ -9°F) Default Setting : 0°C]

Daily Temp. Range(D.T.G) setting method

- ▶ Press **(D.T.G)** button pressing **(SET)** button to turn on TEMP. GAP lamp and turn ON daily temperature range. And turn off run lamp to turn OFF daily temperature range. [Default Setting : ON]

- ▶ Daily temperature range (D.T.G)?
 It is a function artificially making the highest time zone of temperature by sun at the natural condition, and it is a function that can raise the incubation success rate of reptile by the optimal incubation environment by raising temperature at the fixed time zone.

Tip When D.T,G function operates, TEMP. GAP lamp flickers. D.T,G function is 1.5°C (2.7°F) higher than the existing set temperature once a day for 3 hours.
 ex) In case that reptile incubation temperature is 28.5°C (83.3°F), it is kept at 30°C (86°F) once a day for 3 hours.

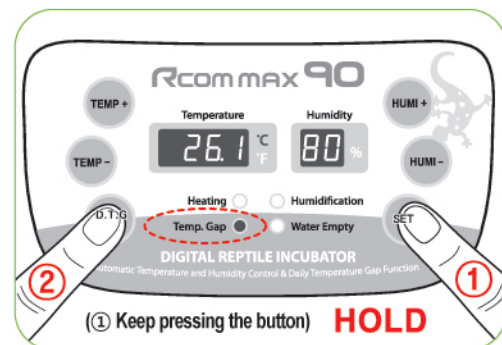

How to change Cels. & Fahr.

- ▶ Press **(TEMP+)** button and **(TEMP-)** button at the same time and press **(SET)** button at the state that CA was displayed on temperature display window to change it.

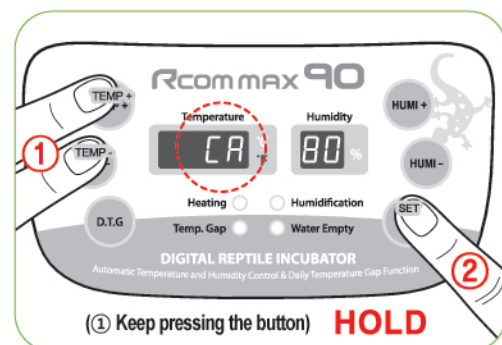

Disassembling and Cleaning the Incubator

- ▶ Pull out the electric cord from the connecting jack and also take out the plug from the outlet.

! In case of turning off the power immediately after using incubator, it may be a cause of breakdown because of the humidity remaining in the inside of main controller. Then, it is necessary to turn it off after operating about for 1 hour at the state of removing water for humidification of the incubator inside or reoperate it after opening sight glass and naturally drying for 2~3 hours in order to use machine for a long time.

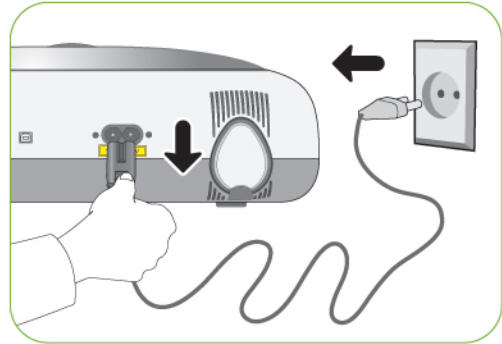

Unlock and remove the locking buttons for three parts at the front and back of incubator by pulling them forward.

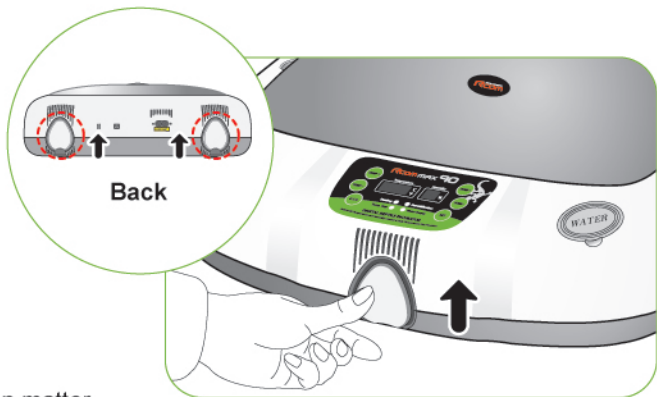

Dry main body(bottom) and tray after washing with water cleanly and dry main body(up) about for one day at airy area in order to remove remaining humidity in the inside completely.

- ▶ When using humidification function, a lot of alien matter sticks to the humidification heating element ①. This may not cause failure, but when terminating incubation please clean the humidifying heater lightly with a soft brush.

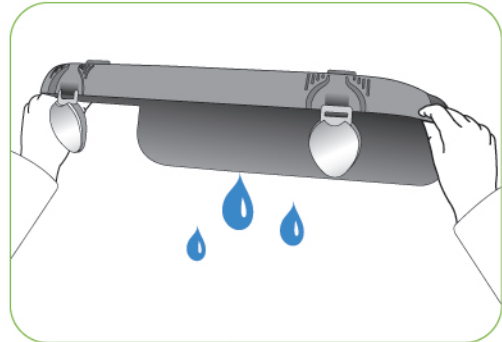

Tip In case of using distilled water as water for humidification, it is possible to reduce foreign substance(scale) noticeably.

- ▶ If you place the main body(upper part) on the floor, please don't let the humidification heating part touch with the floor.

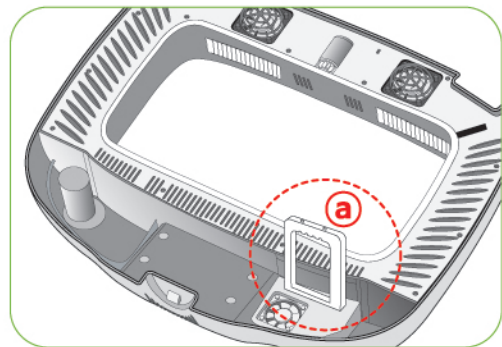

! In case of giving some shock on the heater part ① for humidification or drawing it with a sharp thing, the heater for humidification is damaged.

! In order to reduce foreign substance(scale) of the heater part ① for humidification, it is recommendable to use distilled water as water for humidification. In case of wanting to use other water, be sure to use it after inquiring to the store purchased.

Start the vacuum cleaner to remove the dust as shown on the right and thoroughly shake out the minute dust with a fine brush.

Tip If the incubator goes through incubations several times, dust, shell, etc. accumulate inside the main body, which may cause a break down, so be sure to clean the product before storage.

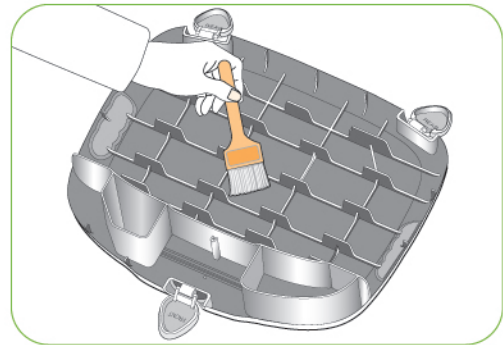

! In case the incubator clean status is poor which may cause fan noisy or stopping.

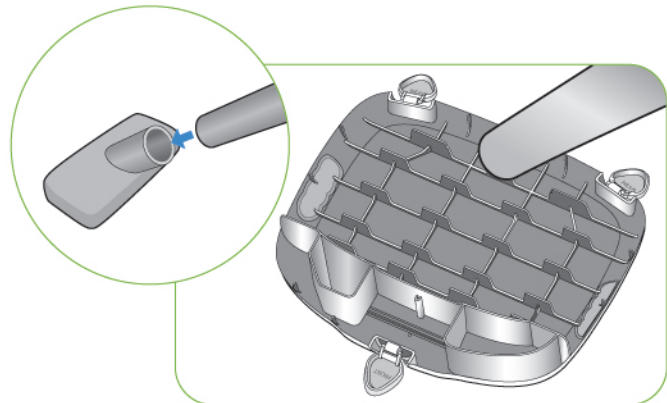

If you finish cleaning the incubator, reassemble it in the reverse order of disassembly. Wipe out outside the main body with a wet cloth and dry it in a cool and well-ventilated place before storage.

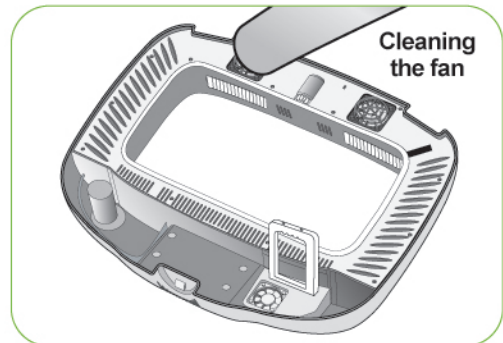

Tip [Refer to How to assemble on Page 7.]

! Don't clean the product with organic solvents such as benzene, thinner, etc. which may cause deformation or decoloration.

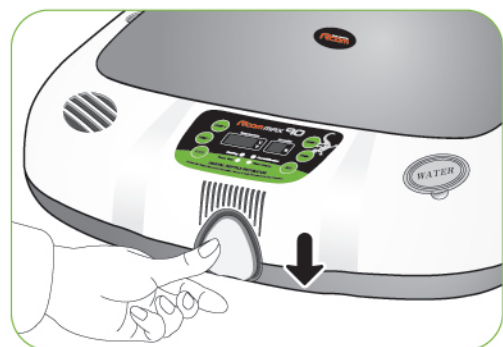

Recommended temp. and humi. table by reptile during incubation

Reptile Grouping	SPECIES	INCUBATION PERIOD	TEMPERATURE	HUMIDITY	DAILY TEMPERATURE GAP
Chameleon	Veiled Chameleon	145-180 days	26.1°C / 79°F	80%	
Turtle	Box Turtles	70-80 days	27.8°C / 82°F	85%	
	Sea Turtle	58-62 days	29.4°C / 85°F	95%	
	Painted Terrapin Turtle	72-80 days	29.4°C / 85°F	95%	
	Snapping Turtle	60-85 days	29.4°C / 85°F	95%	
Tortoise	Desert Tortoise	85-90 days	30.6°C / 87°F	80%	
	European Tortoise	56-84 days	30.6°C / 87°F	75%	
	Mediterranean Tortoise	56-70 days	30.6°C / 87°F	75%	
Snake	North American King Snake	60-65 days	28.3°C / 83°F	90%	
	North American Milk Snake	60-65 days	28.3°C / 83°F	90%	
	North American Rat Snake	60-65 days	28.3°C / 83°F	90%	
	Corn Snake	55-60 days	29.4°C / 85°F	85%	
	King Snake	60-65 days	28.3°C / 83°F	90%	
	Amazon Tree Boa	40-50 days	31.1°C / 88°F	95%	
	Python	60-65 days	32.2°C / 90°F	90%	
Iguana	Green Iguana	73-80 days	29.4°C / 85°F	85%	
Lizard	Bearded Dragon Lizard	60-70 days	28.9°C / 84°F	85%	
	Uromastyx	55-65 days	33.9°C / 93°F	92%	1.5°F/3hour
	Chinese water dragon	60-75 days	29.4°C / 85°F	85%	
	Tegu	60-70 days	28.3°C / 83°F	90%	
	Lizard	50-60 days	30.6°C / 87°F	87%	
	Day Gecko	50-65 days	27.8°C / 82°F	75%	
	Gecko	50-55 days	29.4°C / 85°F	88-90%	1.5°F/3hour
Alligator	Alligator (Mississippiensis)	63-84 days	31.7°C / 89°F	95%	
	Crocodile (Crocodylus porosus)	89-95 days	30.6°C / 87°F	95%	
Other	Unknown Reptile	50-90 days	30.6°C / 87°F	85%	

※ The recommended environmental conditions as the reptiles may differ slightly.

Troubleshooting

For more detailed self-diagnosis, see Rcom homepage "SELF DIAGNOSIS" category.

All our Rcom digital products of Autoelex Co., Ltd. are made by precision systems under strict quality control. But occasionally some defective products are found on the way of their distribution. If any problem occurs, then please contact Autoelex service center or distributors in your country. We will do our best to solve the problems, if any, for you. This product is designed in modular mode, so for its repair, if any, a qualified person can replace the part concerned with ease.

* Complaint Department : 82-55-337-2560

* E-mail Receipt : Rcom@Rcom.co.kr

Troubles	Expected Causes (Possibility)	Countermeasures
No signs of power to the incubator.	<ul style="list-style-type: none"> ▶ Check if power cord was connected well. ▶ Check power failure. ▶ Check if plug is defective. 	<ul style="list-style-type: none"> ▶ Try to plug-in again. ▶ Check other electric and electronic product nearby. ▶ Check after moving to other socket.
When temperature is too high / When temperature is too low	<ul style="list-style-type: none"> ▶ Check set temperature. ▶ Check if FAN for air circulation doesn't rotate. ▶ Try to make factory initialization. [See 11 page] 	<ul style="list-style-type: none"> ▶ Adjust set temperature to wanted temperature. ▶ Unplug from socket and separate main body to clean FAN area for air circulation with a brush or writing brush.
When humidity is too high / when humidity is too low	<ul style="list-style-type: none"> ▶ Try to make factory initialization. [See 11 page] <p><When low></p> <ul style="list-style-type: none"> ▶ Check if sight window closed well. <p><When high></p> <ul style="list-style-type: none"> ▶ Check surrounding environment. ▶ Check if tray inside or main body(bottom) contains water. 	<ul style="list-style-type: none"> ▶ Refill water sufficiently. <p><when low></p> <ul style="list-style-type: none"> ▶ Check if foreign substance was inserted and close it again. <p><when high></p> <ul style="list-style-type: none"> ▶ Adjust environment of incubation room. [See 7 page]
The machine makes some noise. It is normal that the machine emits some sounds because it uses air circulation fan for working.	<ul style="list-style-type: none"> ▶ Check if there is some other object on the incubator. ▶ Check if there is some vibration on the floor or it was installed on the desk. ▶ Check if some foreign substance was attached to FAN area after incubation. 	<ul style="list-style-type: none"> ▶ Remove all the objects put on the incubator. ▶ Move incubator to the safe place to install. ▶ Unplug from socket and separate main body to clean FAN area for air circulation with a brush or writing brush.
Water leaks from the machine. * In case of keeping at high humidity, there may be some dew.	<ul style="list-style-type: none"> ▶ As reptile incubator operates at high humidity, there is some dew on the sight window. It isn't a breakdown but natural phenomenon. 	<ul style="list-style-type: none"> ▶ Please install within the condition of incubation room.

 **Before inserting eggs, please start incubation after checking if all functions work without any problem by operating incubator sufficiently.**

Specification

1-1 Name : Rcom Reptile MAX 90
1-2 Model : MX-R90

Power	AC 100~120[V], 50/60[Hz] AC 220~240[V], 50/60[Hz]		
Temp. Control Range	20 ~ 42[°C] / 68 ~ 107.6[°F]	Outside Environment Temp.	Optimal range : 22 ~ 25[°C] / 71.6 ~ 77[°F]
			(Low) 20[°C] / 68[°F] (High) 26[°C] / 78.8[°F]
Humi. Control Range	40 ~ 95[%] (It can be changed according to the conditions)		
Temp. and Humi. accuracy	±0.5[°C], ±0.9[°F] / ±5[%]		
Capacity	90[eggs] (Different from the species of egg)		
Power Consumption	Average 48[W] Max. 65[W]		
Product Weight	4.35[Kg]		
Product Size	(W)500×(L)410×(H)160[mm]		
FUSE Standard	250[V] 2.0[A] (Ø5*20[mm])		

Register your product Serial No. on our website for free 2 years gurantee.
 Refer to website for how to register. (Free 1 years gurantee in case not registerd.)

※ Product Registration Procedures

If you are a new member of Rcom, you need to log in our website at www.Rcom.co.kr

1. Click "SIGN UP" on top of the right corner.
2. Fill out the information on the blanks.

If you already registered your information on the Rcom website, please log in to www.Rcom.co.kr.

1. Click "Login" on top of the right corner.
2. Select "Customer" and click "Register Products".
3. Fill out the information on the blanks.

You will need below information to register on our website.

1. Your name
2. Your (home/company) address & Email address, country
3. Your product(model) name & Serial number
4. Date of purchase & Name of purchased shop you bought from

Rcom Incubator Series

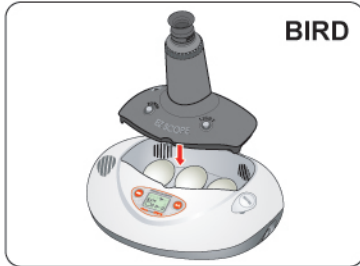

BIRD

Rcom PRO MINI Package (PX-03S)

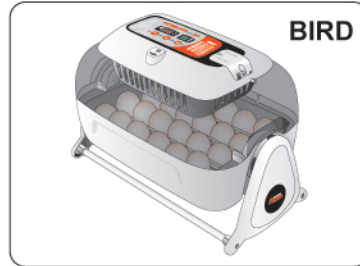

BIRD

Rcom KINGSURO MAX 20 (MX-SURO)

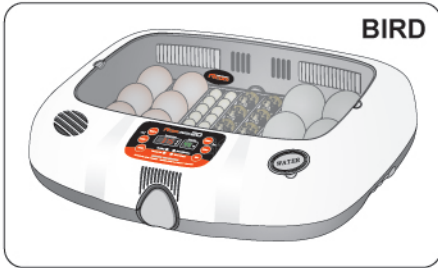

BIRD

Rcom MAX 20 (MX-20)

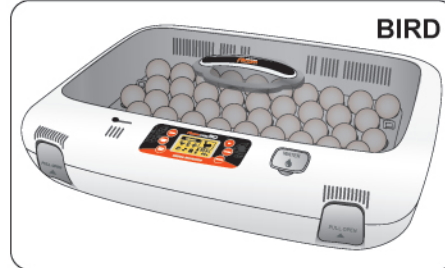

BIRD

Rcom PRO 50 (PX-50)

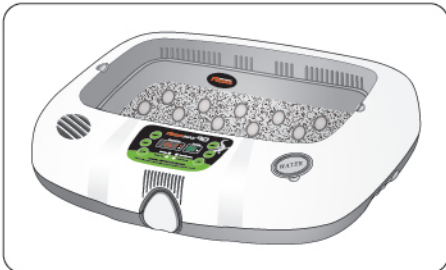

Rcom REPTILE MAX 90 (MX-R90)



Rcom REPTILE PRO 90 (PX-R90)

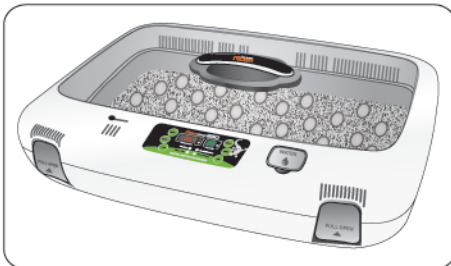

Rcom REPTILE MAX 230 (MX-R230)



Rcom REPTILE PRO 230 (PX-R230)



Rcom REPTILE MAX 60 (MX-R60)



Rcom DIGILOG
(PX-V1)



Rcom DIGILOG2
(PX-V2)

It is possible to check additional information at Rcom homepage (www.R-com.co.kr).





www.Rcom.co.kr

SELLER

--

MANUFACTURER

AUTOELEX CO.,LTD.

- OFFICE : 218, Sangdong-ro, Sangdong-myeon, Gimhae-si, Gyeongsangnam-do, 50805 Korea
- TEL : +82-55-1588-8771
- FAX : +82-55-1544-2862
- E-MAIL : Rcom@Rcom.co.kr